

PROPRIETARY AND CONFIDENTIAL

THE INFORMATION CONTAINED IN THIS DRAWING IS THE SOLE PROPERTY OF UNICE E-O SERVICES INC. ANY REPRODUCTION IN PART OR AS A WHOLE WITHOUT THE WRITTEN PERMISSION OF UNICE E-O SERVICES INC IS PROHIBITED.

A
B
C
D
E
F

A
B
C
D
E
F

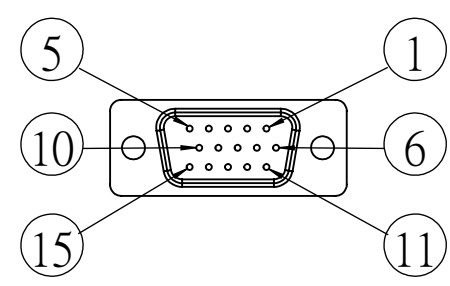
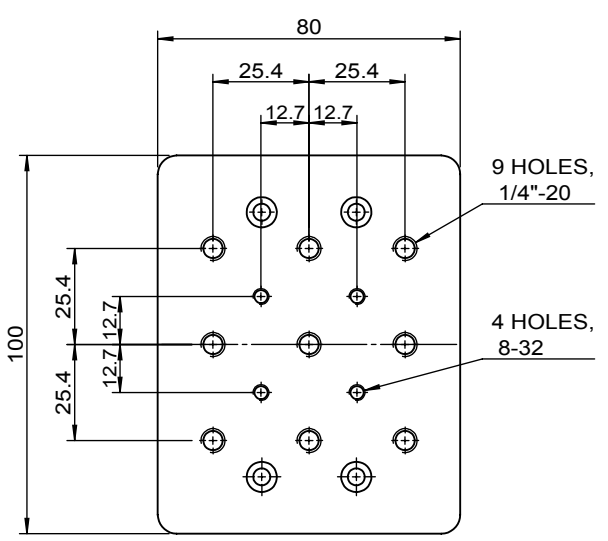
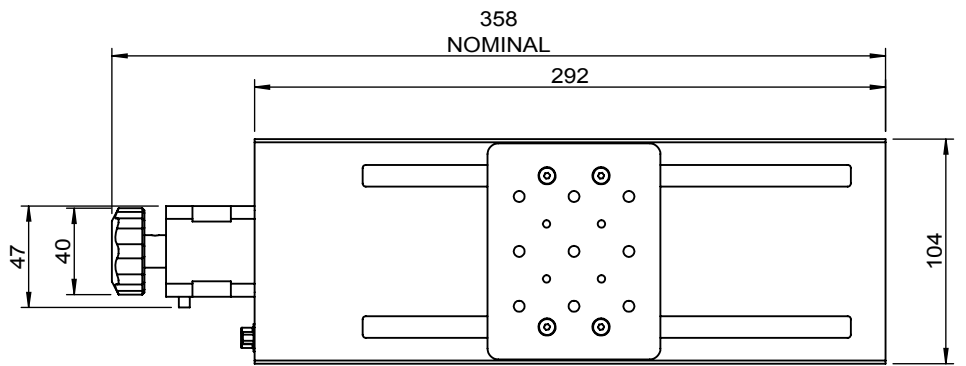

| NO | Description |
|----|-------------|
| 1 | +5V |
| 2 | COM |
| 3 | + Limit |
| 4 | - Limit |
| 5 | N/A |
| 6 | /A |
| 7 | A |
| 8 | /B |
| 9 | B |
| 10 | N/A |
| 11 | CA |
| 12 | CB |
| 13 | N/A |
| 14 | N/A |
| 15 | N/A |

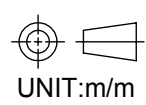
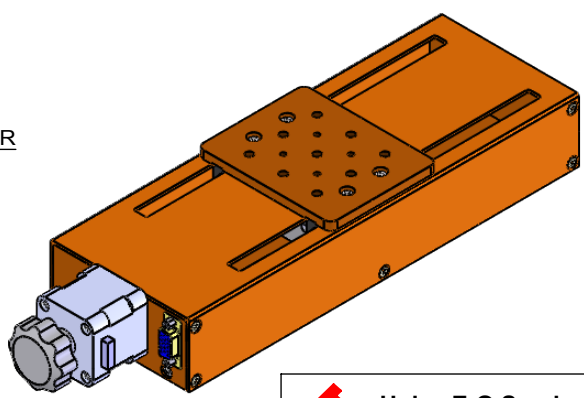
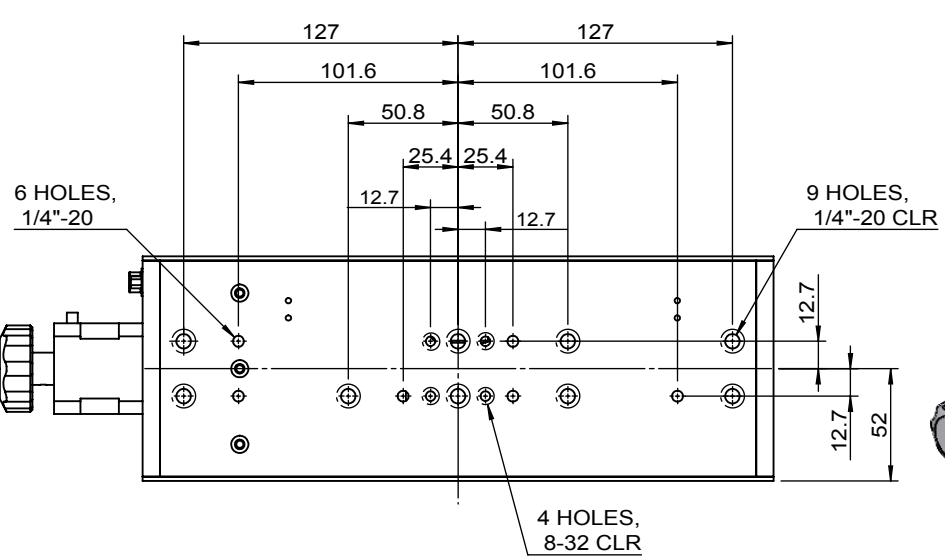
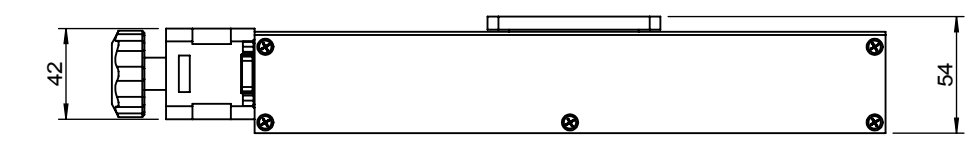

| | | | | |
|--|--------|------------|-----------|-----------|
|  Unice E-O Services Inc. No.5, Andong Rd., Chung Li District, Taoyuan City 32063, Taiwan, R.O.C. | | | TITLE: | |
| | | | 08UMT-150 | |
| | | | DWG. NO. | 08UMT-150 |
| | | | MATERIAL: | N/A |
| DRAWN | Sky | 2018/10/15 | SCALE: | 1:3.5 |
| ENG APPR. | Johnny | 2018/10/15 | REV | 0 |

1 2 3 4 5 6 7 8