

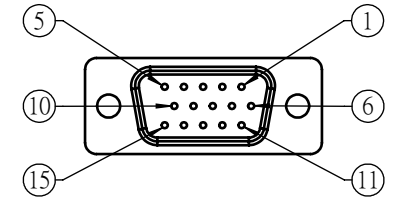

PROPRIETARY AND CONFIDENTIAL

THE INFORMATION CONTAINED IN THIS DRAWING IS THE SOLE PROPERTY OF UNICE E-O SERVICES INC. ANY REPRODUCTION IN PART OR AS A WHOLE WITHOUT THE WRITTEN PERMISSION OF UNICE E-O SERVICES INC IS PROHIBITED.

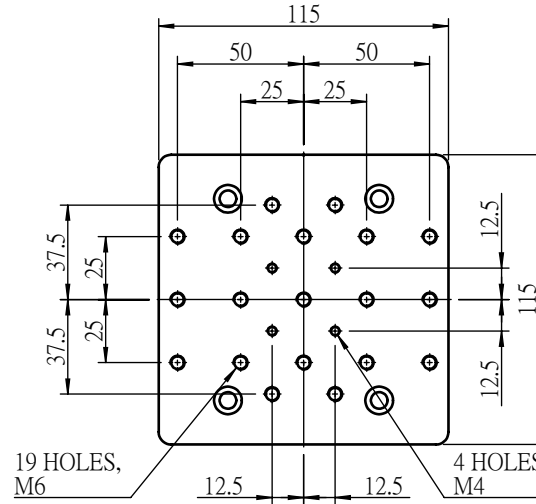
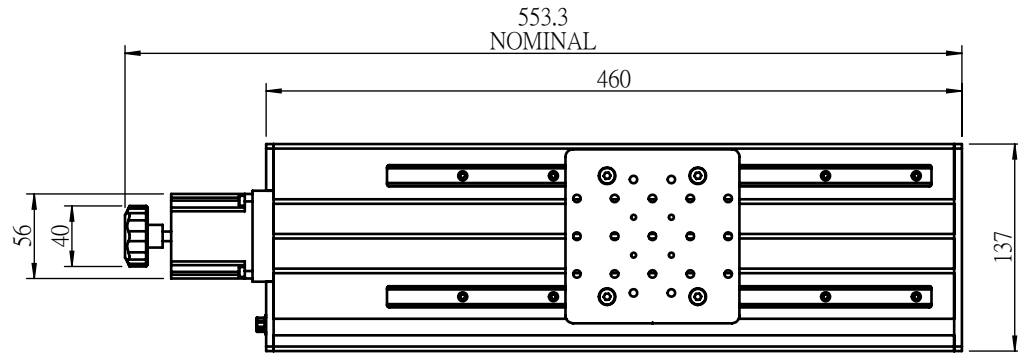
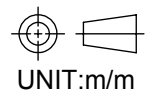
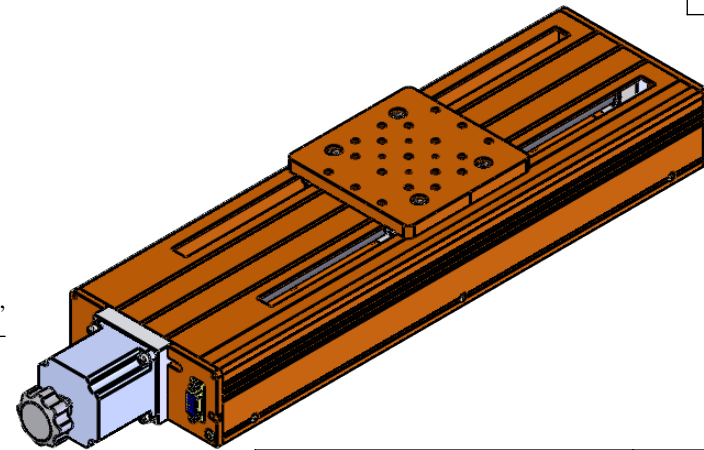
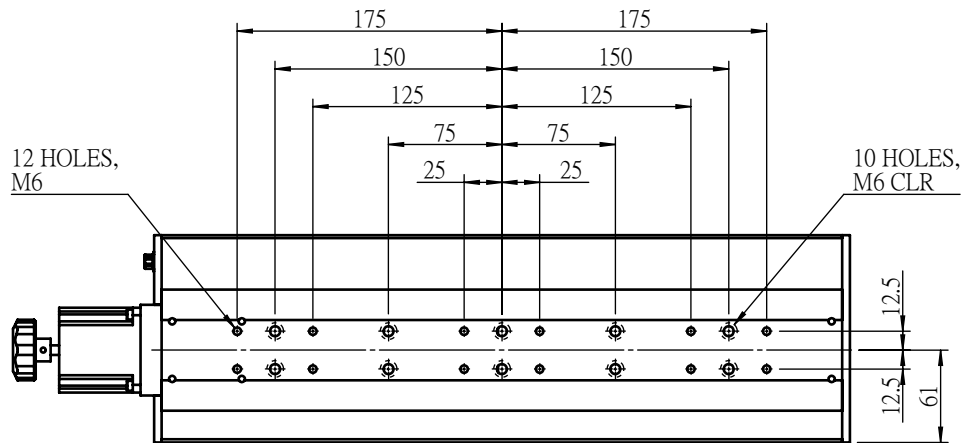
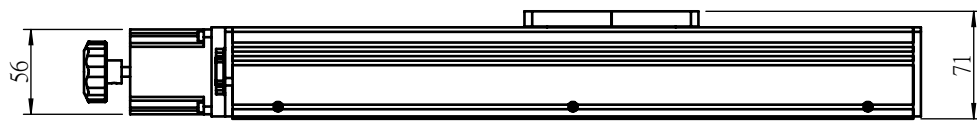

NO	Description
1	+5V
2	COM
3	+ Limit
4	- Limit
5	N/A
6	/A
7	A
8	/B
9	B
10	N/A
11	CA
12	CB
13	N/A
14	N/A
15	N/A



 Unice E-O Services Inc. No.5, Andong Rd., Chung Li District, Taoyuan City 32063, Taiwan, R.O.C.			TITLE:	
			08PMT-250M	
			DWG. NO.	08PMT-250M
			MATERIAL:	N/A
DRAWN	Sky	2018/10/8	SCALE:	1:5
ENG APPR.	Johnny	2018/10/8	REV	0