

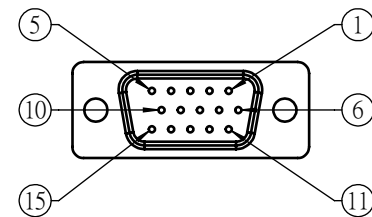

**PROPRIETARY AND CONFIDENTIAL**

THE INFORMATION CONTAINED IN THIS DRAWING IS THE SOLE PROPERTY OF UNICE E-O SERVICES INC. ANY REPRODUCTION IN PART OR AS A WHOLE WITHOUT THE WRITTEN PERMISSION OF UNICE E-O SERVICES INC IS PROHIBITED.

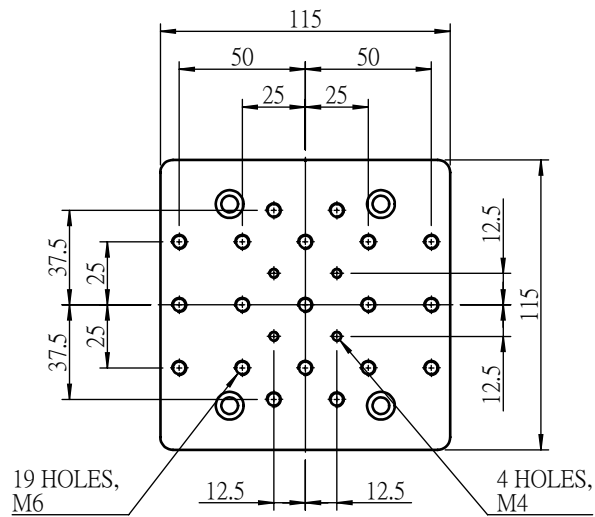
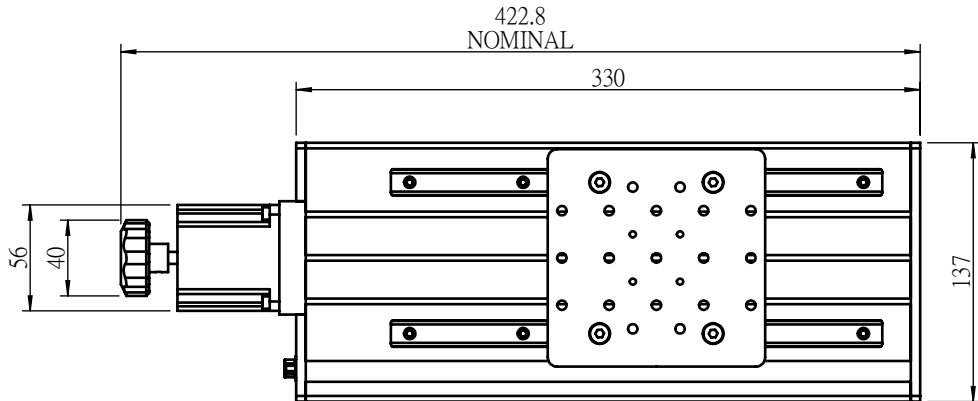
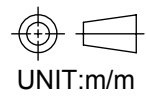
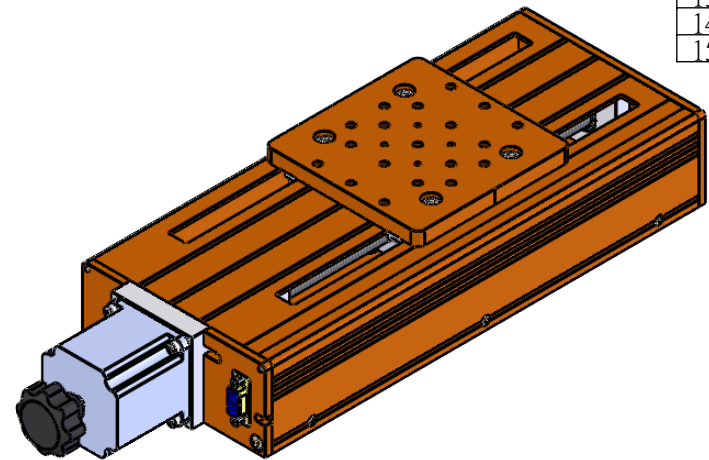
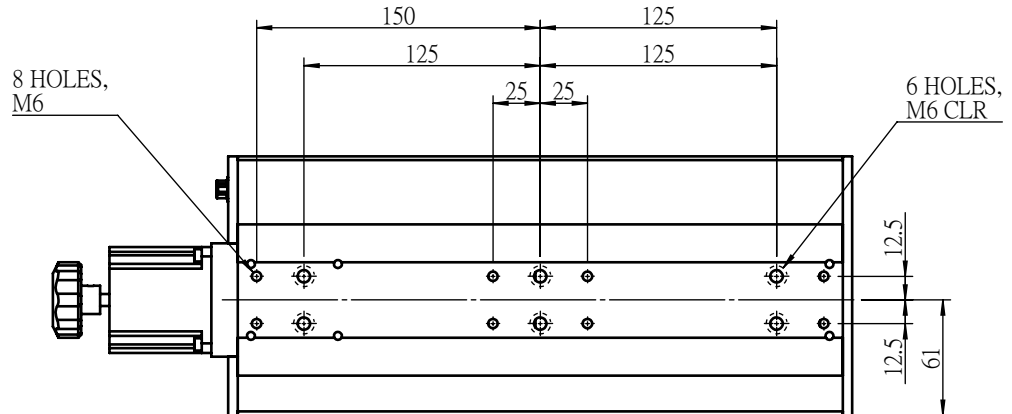
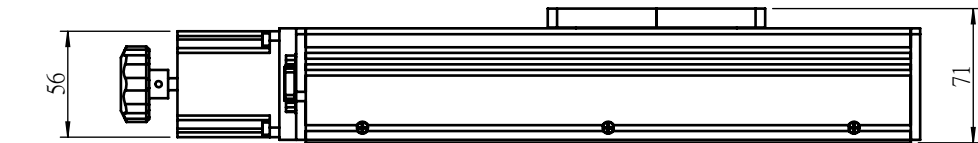

| NO | Description |
|----|-------------|
| 1  | +5V         |
| 2  | COM         |
| 3  | + Limit     |
| 4  | - Limit     |
| 5  | N/A         |
| 6  | /A          |
| 7  | A           |
| 8  | /B          |
| 9  | B           |
| 10 | N/A         |
| 11 | CA          |
| 12 | CB          |
| 13 | N/A         |
| 14 | N/A         |
| 15 | N/A         |



|  |        |           |            |            |
|--|--------|-----------|------------|------------|
|  <b>Unice E-O Services Inc.</b><br>No.5, Andong Rd., Chung Li District,<br>Taoyuan City 32063, Taiwan, R.O.C. |        |           | TITLE:     |            |
|  |        |           | 08PMT-150M |            |
|  |        |           | DWG. NO.   | 08PMT-150M |
|  |        |           | MATERIAL:  | N/A        |
| DRAWN  | Sky    | 2018/10/5 | SCALE:     | 1:4        |
| ENG APPR.  | Johnny | 2018/10/5 | REV        | 0          |