

**PROPRIETARY AND CONFIDENTIAL**

THE INFORMATION CONTAINED IN THIS DRAWING IS THE SOLE PROPERTY OF UNICE E-O SERVICES INC. ANY REPRODUCTION IN PART OR AS A WHOLE WITHOUT THE WRITTEN PERMISSION OF UNICE E-O SERVICES INC IS PROHIBITED.

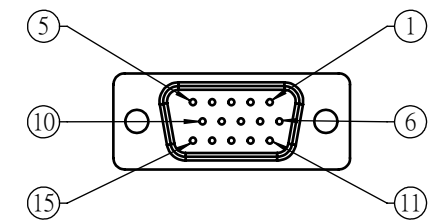

| NO | Description |
|----|-------------|
| 1  | +5V         |
| 2  | COM         |
| 3  | + Limit     |
| 4  | - Limit     |
| 5  | N/A         |
| 6  | /A          |
| 7  | A           |
| 8  | /B          |
| 9  | B           |
| 10 | N/A         |
| 11 | CA          |
| 12 | CB          |
| 13 | N/A         |
| 14 | N/A         |
| 15 | N/A         |

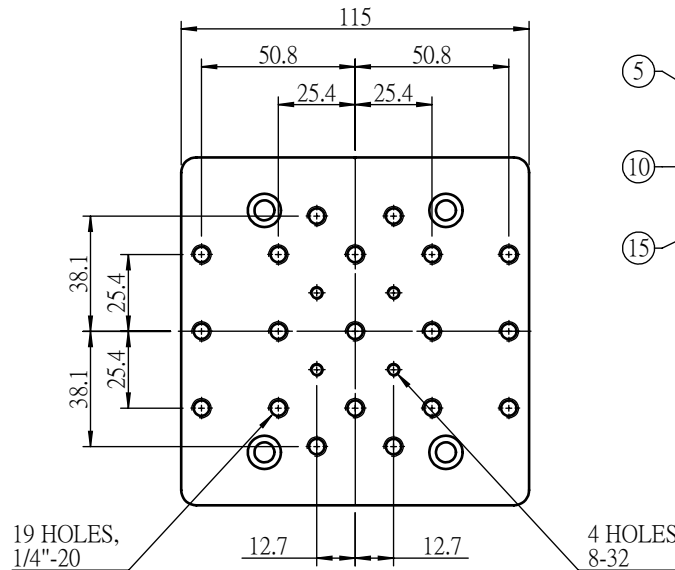
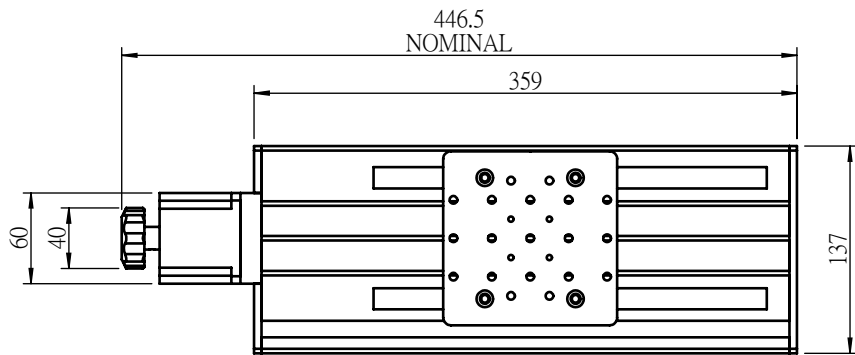
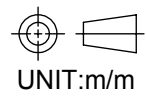
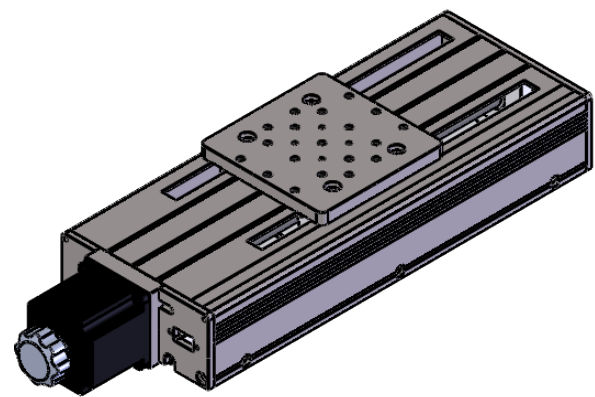
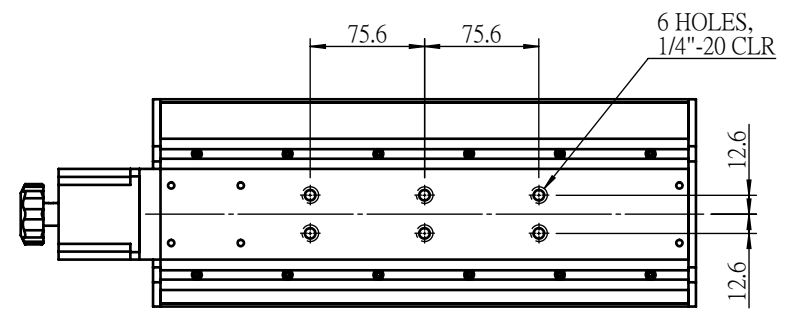
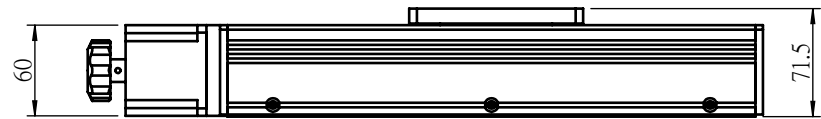

UNIT:m/m

|                                                                                                                                                                                                    |        |          |           |           |
|----------------------------------------------------------------------------------------------------------------------------------------------------------------------------------------------------|--------|----------|-----------|-----------|
|  <b>Unice E-O Services Inc.</b><br>No.5, Andong Rd., Chung Li District,<br>Taoyuan City 32063, Taiwan, R.O.C. |        |          | TITLE:    |           |
|                                                                                                                                                                                                    |        |          | 08HMT-150 |           |
|                                                                                                                                                                                                    |        |          | DWG. NO.  | 08HMT-150 |
|                                                                                                                                                                                                    |        |          | MATERIAL: | N/A       |
| DRAWN                                                                                                                                                                                              | Sky    | 2019/5/2 | SCALE:    | 1:5       |
| ENG APPR.                                                                                                                                                                                          | Johnny | 2019/5/2 | REV       | 0         |